

05

Decking



Tarimatec

En la actualidad, los pavimentos trascienden su papel funcional para convertirse en una expresión clave del diseño arquitectónico. Gracias a la innovación tecnológica, exploramos una amplia gama de colores, acabados y formatos que añaden un toque distintivo a cualquier espacio. No se trata solo de superficies, sino de **elementos de diseño que transforman y realzan la estética de cada entorno.**

In modern life, flooring has transcended its functional role to become a key element of expression within architectural design. Through technological innovation, we explore a wide range of colours, finishes and formats to add a distinctive touch to any space. These are not just surfaces, these are **design elements that have the potential to transform and enhance the aesthetics of any environment.**

Nuestro catálogo incluye dos tipologías de tarima exterior:

Our catalogues includes two types of outdoor decking:

Deck alveolar Hollow Decking

Nuestra gama deck alveolar ha extendido su presencia a lo largo y ancho del mundo, demostrando una calidad y desempeño que se destaca de manera notable tanto en entornos privados como públicos. Su reputación se erige sobre la base de un comportamiento excepcional, consolidándose como una elección confiable y versátil con el paso del tiempo. Esta innovadora solución para pavimentos ha conquistado espacios de uso residencial, donde la comodidad y la estética se encuentran en armonía, así como en áreas de concurrencia pública, donde la resistencia y durabilidad son requisitos fundamentales. Un testimonio tangible de innovación y rendimiento, que se ha consolidado como una opción líder en el mercado de pavimentos de exterior.

Our hollow decking range has found popularity across the world, proving to deliver remarkable quality and performance that stands out in both private and public environments. Its reputation is built on its exceptional performance, having become established as a reliable and versatile choice over time. This innovative flooring solution is particular popular in residential spaces, where comfort and aesthetics combine in perfect harmony, as well as in public areas, where resistance and durability are fundamental requirements. Undisputed proof of its innovative quality and performance, it has become a leading choice in the outdoor flooring market.

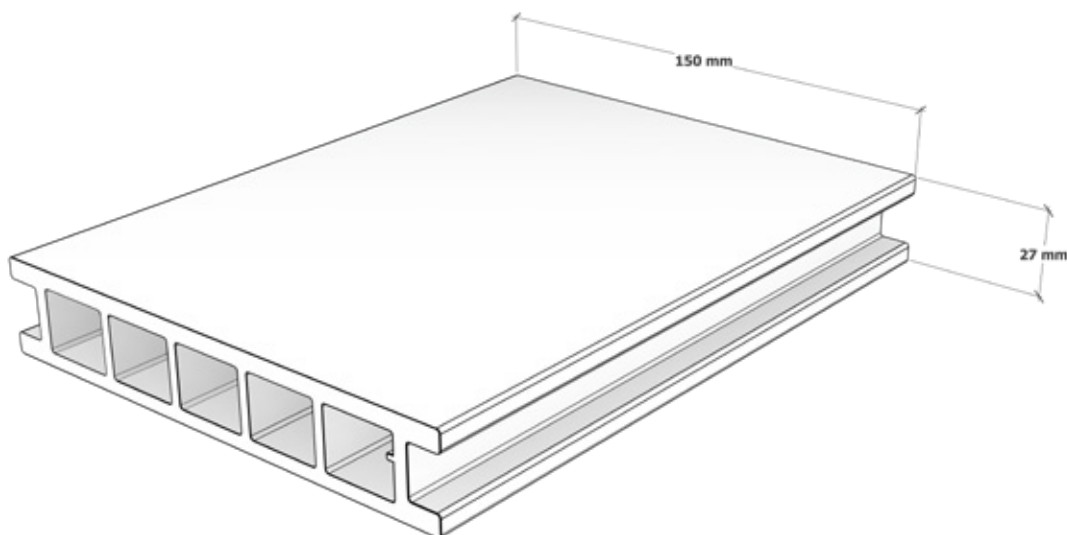

DECK ALVEOLAR se presenta en nuestras tres colecciones principales, siendo así un ejemplo de versatilidad y adaptabilidad.

THE HOLLOW DECKING is available in our three main collections, making it an example of versatility and adaptability.

01 Chromatic

Una gama de colores diseñada para crear espacios únicos y personalizados, que pone de relevancia la versatilidad cromática de nuestra materia prima para poder seleccionar aquella que mejor se adapte a la esencia de cada proyecto. Chromatic tiene cinco referencias de colores planos.

A palette of colours designed to create unique, personalised spaces, this range highlights the chromatic versatility of our raw materials so that you can select the one that best suits the essence of your project. Chromatic offers five flat colours.

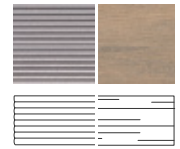

Acabado/Finish
TECNO & NATURE

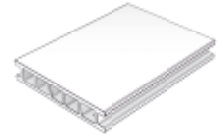

Deck Alveolar

Colores disponibles / Available colours

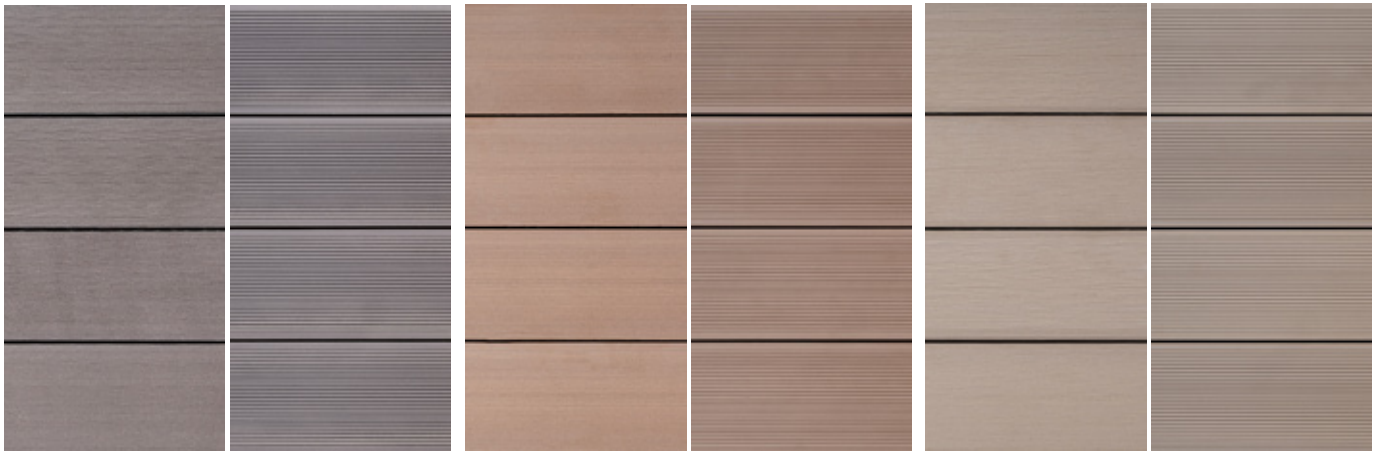

Wengué 2204

Miel 2213

Moka 2241



Marrón 2212

Gris 2214



Project
Pia Paisajismo
Photograph
Nacho Uribe

02 Wood

Los colores Wood de Tarimatec se inspiran en la sinuosa y heterogénea belleza de la madera a través de una materia prima formulada para resistir. Un imprescindible en el diseño de proyectos sostenibles que buscan un estilo cálido y acogedor.

Wood colours by Tarimatec are inspired by the sinuous and heterogeneous beauty of wood through a raw material made to last. This is an essential element for the design of any sustainable project seeking a warm and welcoming style.



Acabado/Finish NATURE

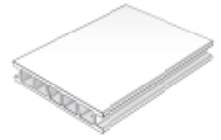

Deck Alveolar



Photograph
Mimus & SUC Estudio

Wood refleja la naturaleza más impredecible en cada uno de sus catorce tonos con inesperadas vetas que hacen que cada lama sea única y original.

Each of the Wood range's 14 shades reflects nature's unpredictability with intriguing grains that make each plank original and unique.

Colores disponibles / Available colours



Nielsen 2481



Cinnamon 2365

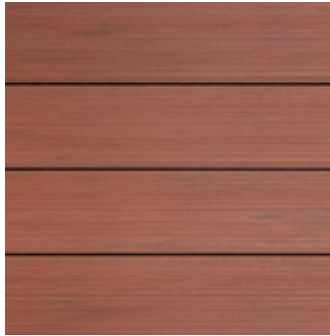

Sándalo 2361



Ipé 2348



Greenwood 2330



Silver 2332

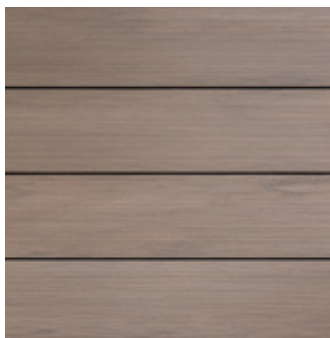

Nogal 2321

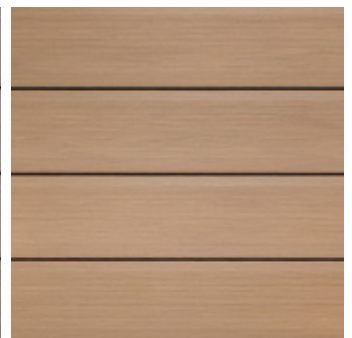

Havana 2482

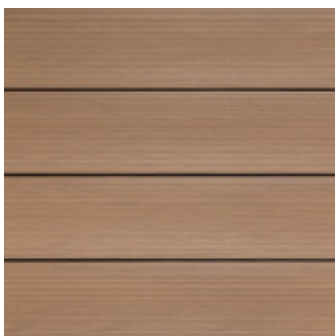

Cozumel 2377

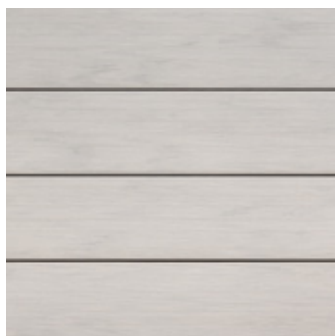

Luna 2364

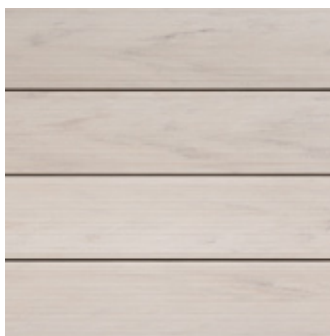

Polar 2347

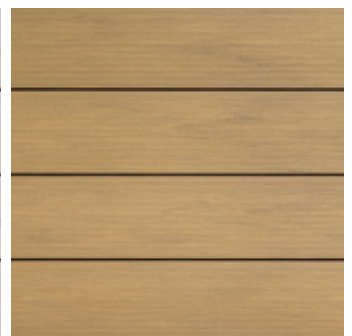

Roble 2349



Castaño 2333



Teka 2326

03 Ethnic

La gama cromática de Ethnic se compone de doce tonalidades originales a las que se incorpora una ligera veta para favorecer la conexión con la propia naturaleza.

The Ethnic chromatic range is composed of twelve original shades with a soft grain to evoke a connection with nature.



Acabado/Finish SURCO

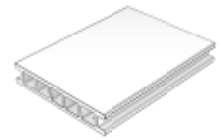

Deck Alveolar

Colores disponibles / Available colours



Antique 2397

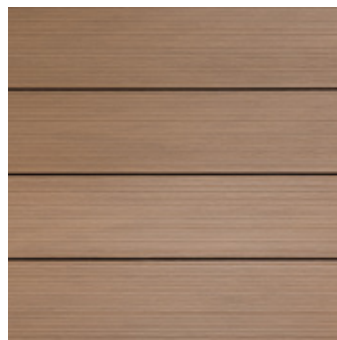

Iroko 2395

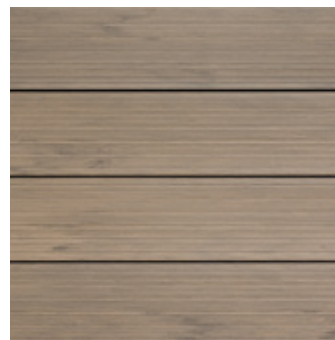

Bambú 2396



Lino 2398



Índigo 2490

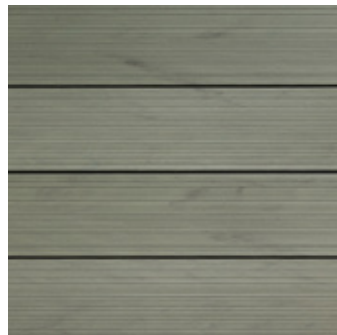

Formentera 2489

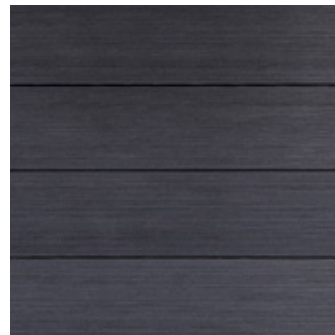

Preto 2301

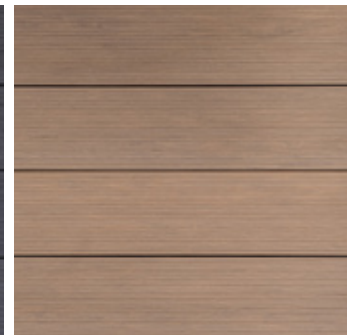

Aloha 2508

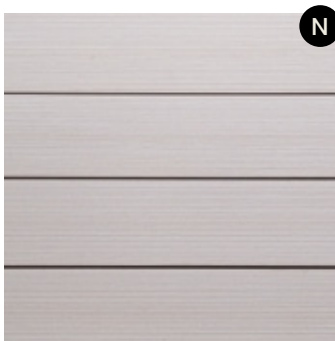

Blanco Ivory 2217

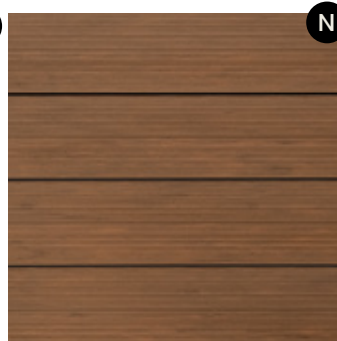

Macao 2520



Koala 2523

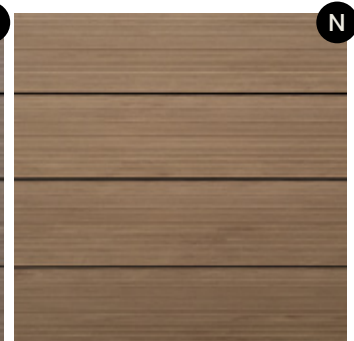

Coffe 2522



Project
Jaime Salvá Arquitectes

Photograph
Mauricio Fuertes

Deck sólida

Solid Decking

Deck sólida se erige como la elección predilecta para aquellas zonas que demandan lo mejor de nuestro pavimento, enfrentándose a condiciones de uso extremas. Diseñada con meticulosidad, esta opción se revela como la solución ideal para espacios de pública concurrencia, donde el tránsito intenso y constante pone a prueba la resistencia y durabilidad del suelo.

Solid decking stands out as the preferred choice for spaces requiring top-quality flooring that can withstand extreme usage conditions. Meticulously designed, it is the ideal solution for public spaces where constant, heavy footfall will put the surface's resistance and durability to the test.

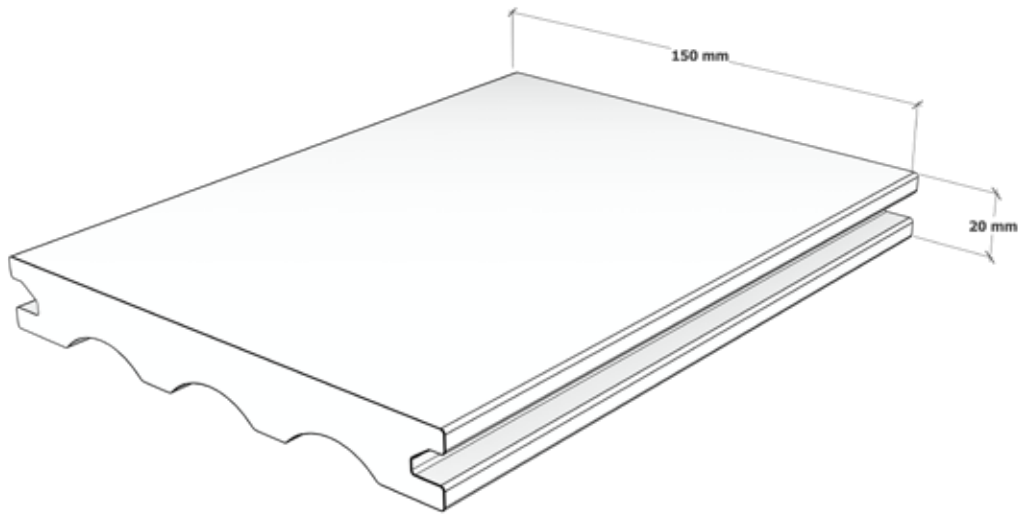

Concebida para afrontar las condiciones más exigentes, esta tarima no solo garantiza una superficie robusta y duradera, sino que también despliega una estética que no compromete el refinamiento. Su calidad excepcional junto con su **acabado nature** se manifiestan en cada detalle, convirtiéndola en la elección perfecta para aquellos entornos que requieren un pavimento con un diseño cálido, que esté a la altura de sus desafíos diarios.

Designed to cope with the most demanding conditions, this decking not only guarantees a robust and durable surface but also offers a highly refined aesthetic quality. Its exceptional production quality and **Nature finish** are evident in every detail, making it the perfect choice for those environments that require a warm design that can withstand challenging conditions.



Project

Alberto García Interior Design



Acabado/Finish NATURE

Colores disponibles / Available colours

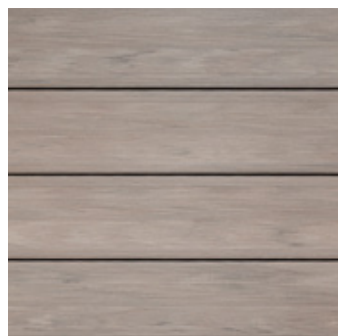

Nielsen 2481

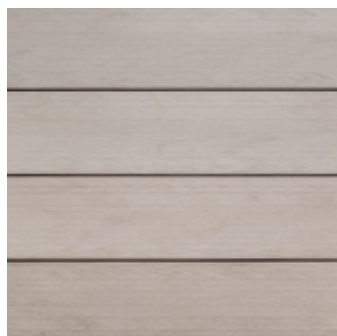

Cinnamon 2365

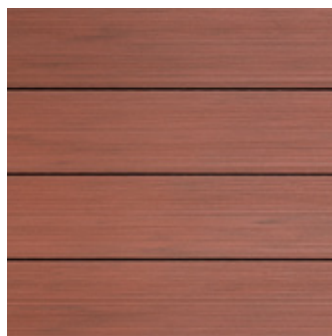

Sándalo 2361

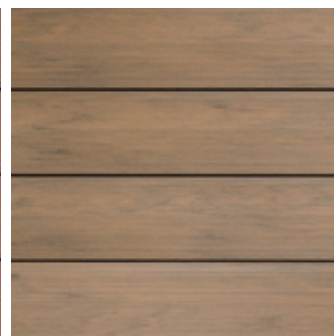

Ipé 2348



Greenwood 2330

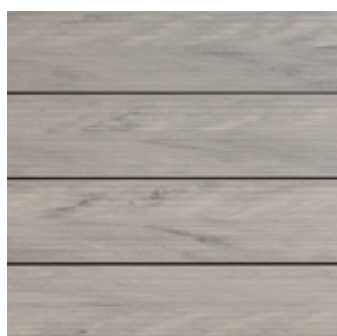

Silver 2332

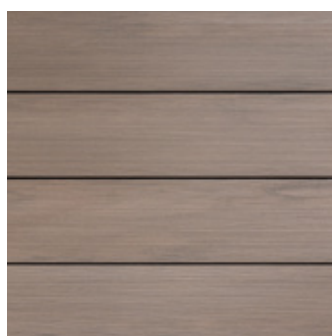

Nogal 2321

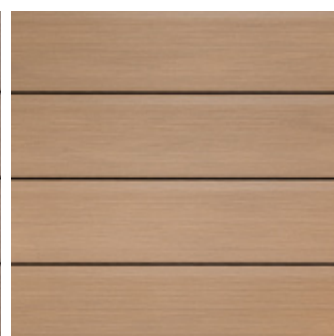

Havanna 2482

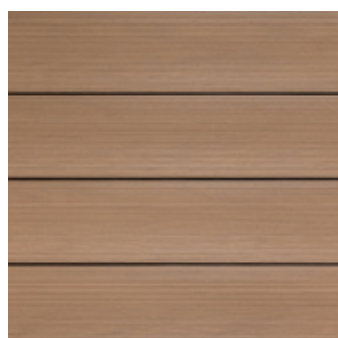

Cozumel 2377

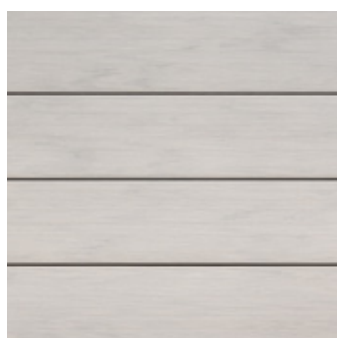

Luna 2364

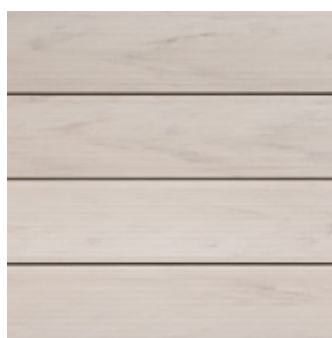

Polar 2347

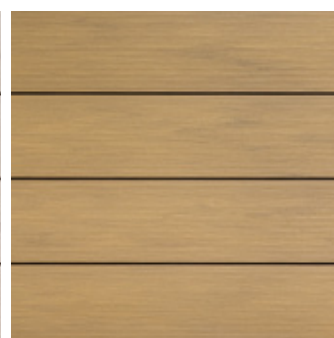

Roble 2349



Castaño 2333



Teka 2326



 **Tarimatec**
www.centrocibic.com

C/ Siurells, 21 Pol. Marratxi
Mallorca, Islas Baleares