

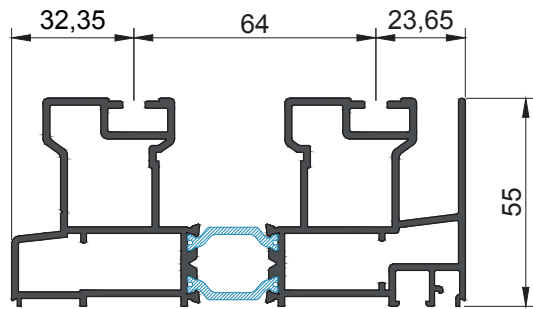

Serie ZEN 120 ELEVABLE

ZENLINE
daylight windows



ABRT120

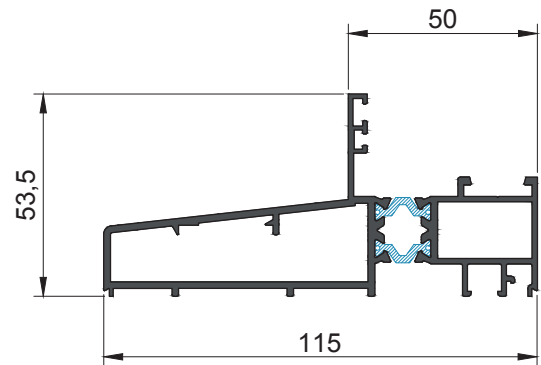

ABRT122

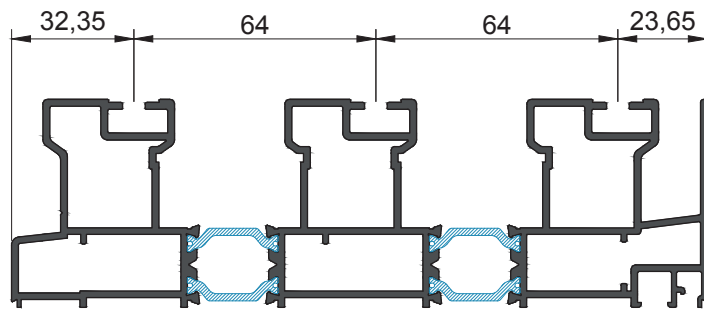

ABRT123

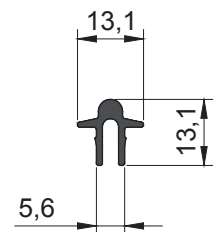

AB71039

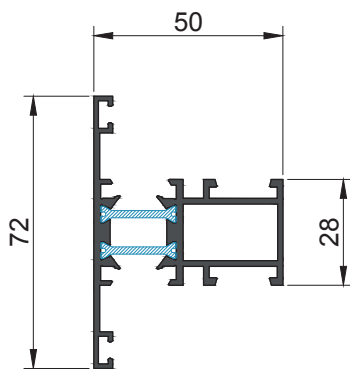

ABRT125

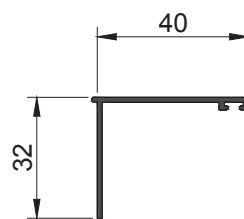

AB17890

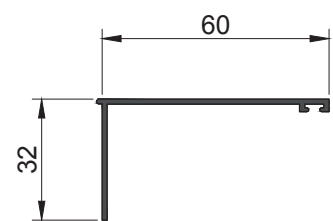

AB17889

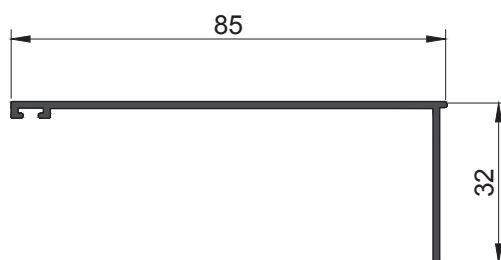

AB16016

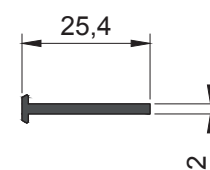

AB63398

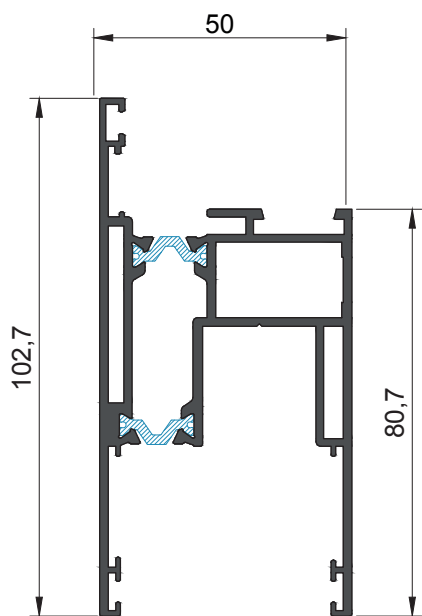

ABRT124

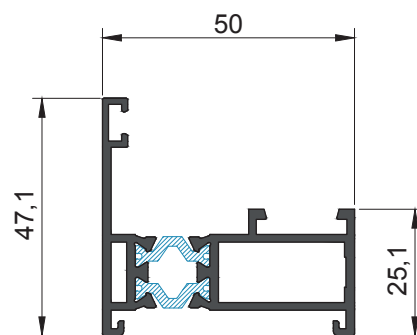

ABRT129

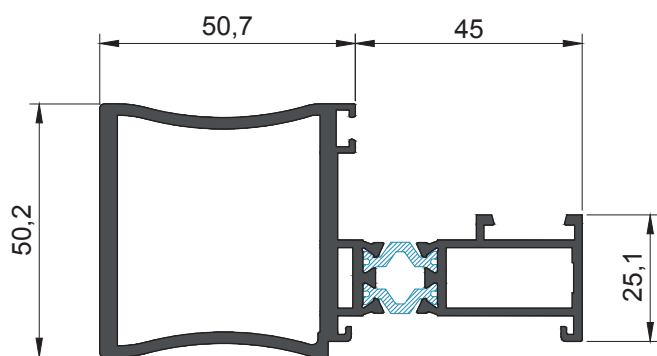

ABRT130



AB50199

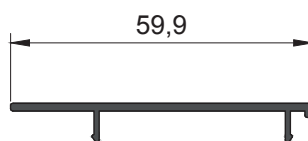

AB16457

CORREDERA DE DOS HOJAS

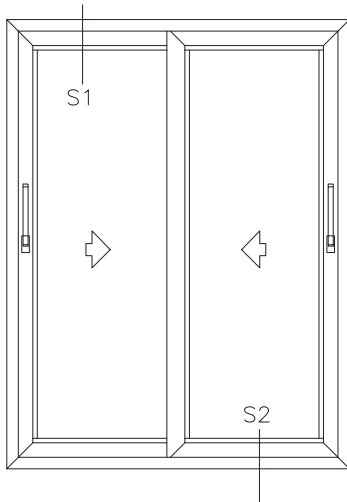

ALZADO

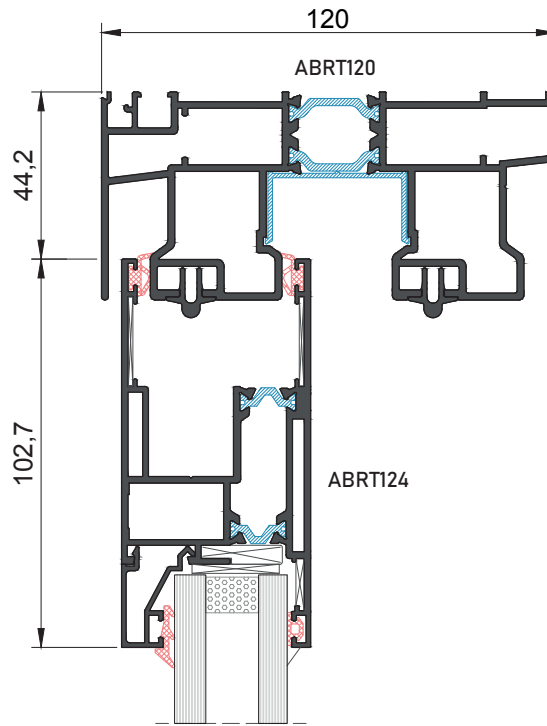

Sección 1

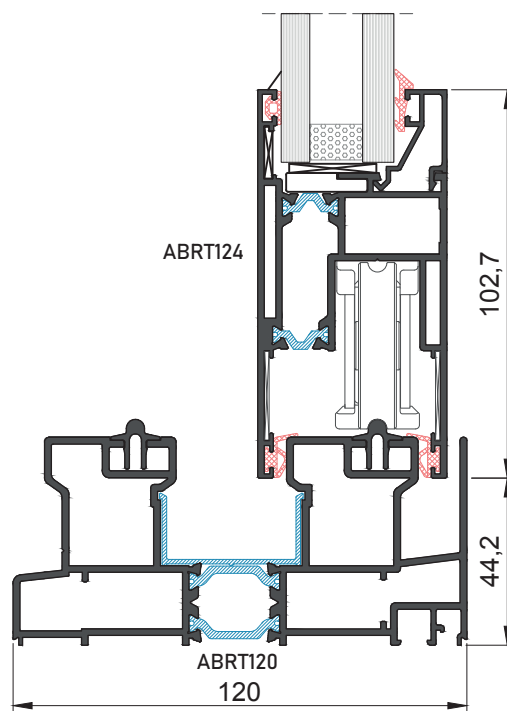

Sección 2

CORREDERA DE DOS HOJAS

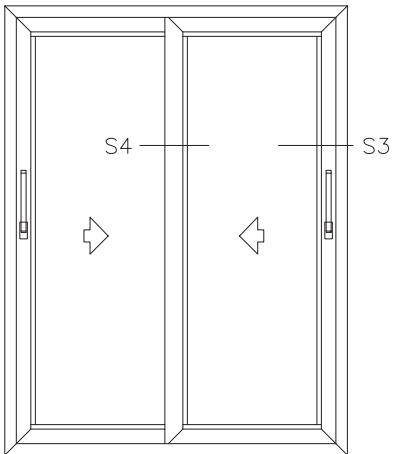

ALZADO

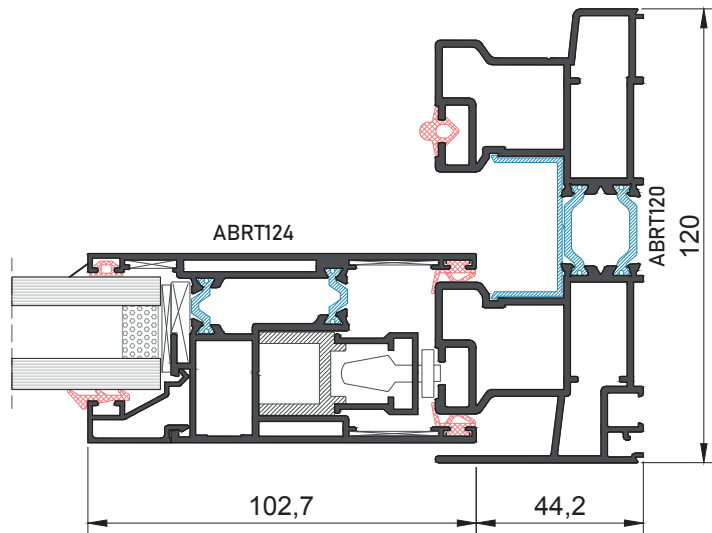

Sección 4

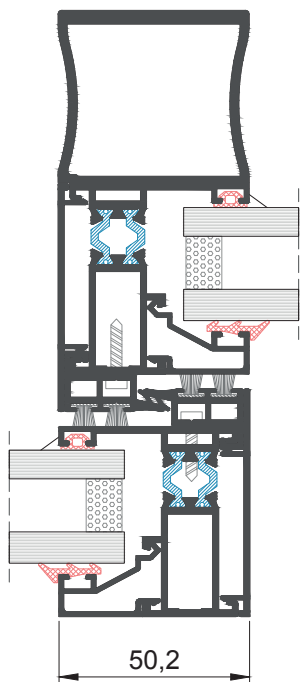

Sección 3

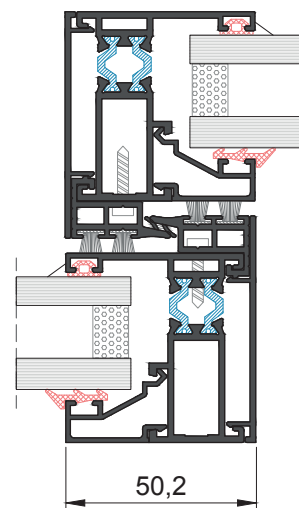

CORREDERA DE CUATRO HOJAS

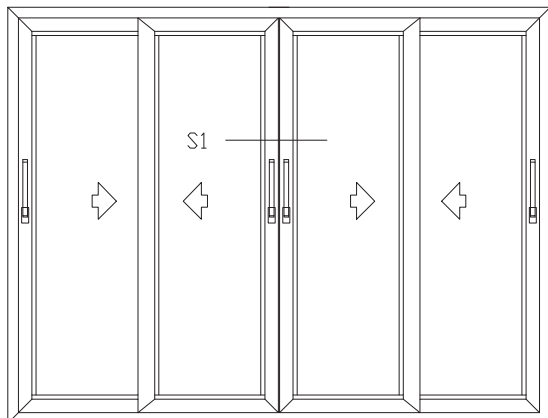

ALZADO

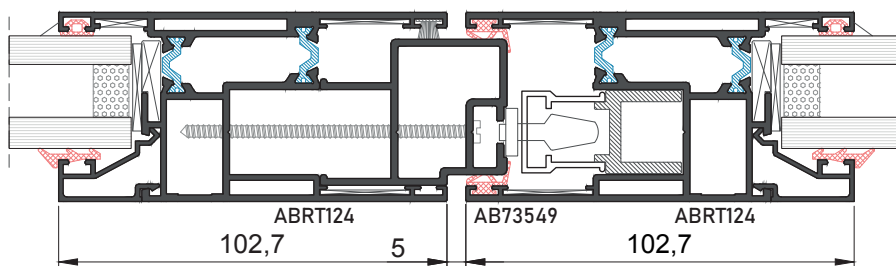

Sección 1

CORREDERA TRES CARRILES

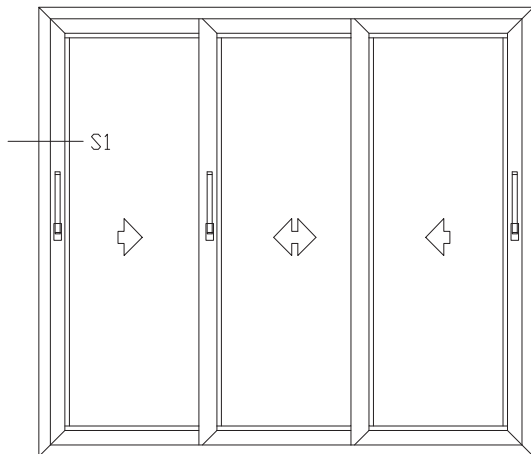

ALZADO

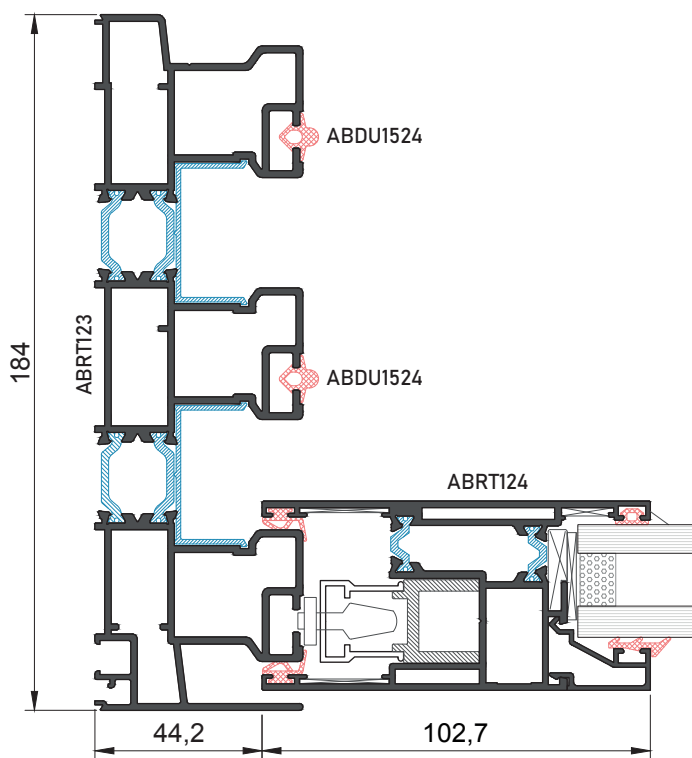

Sección 1

CORREDERA DE UNA HOJA MAS FIJO

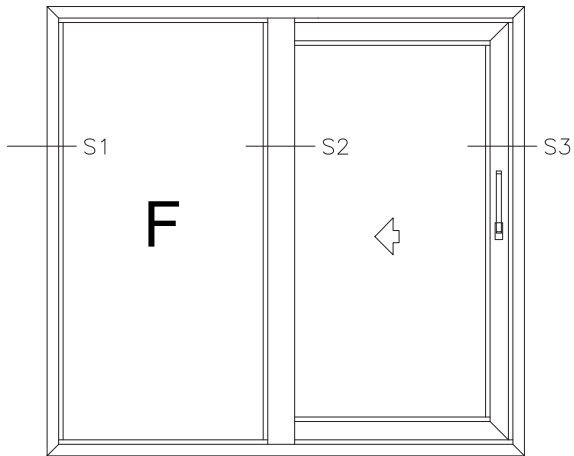

ALZADO

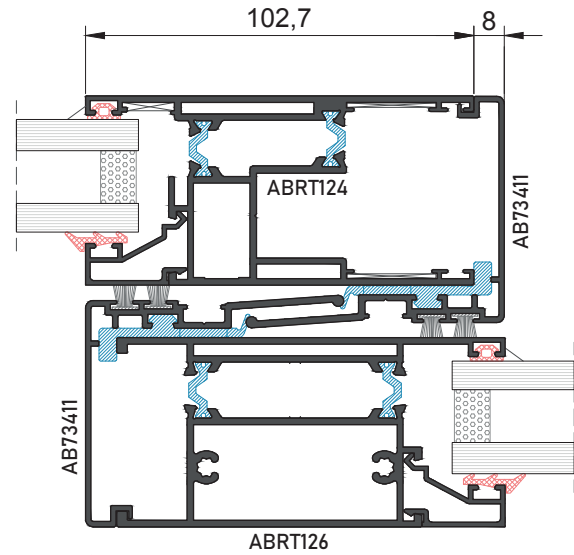

Sección 2

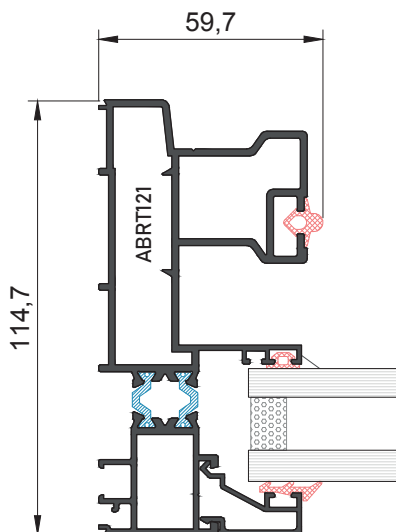

Sección 1

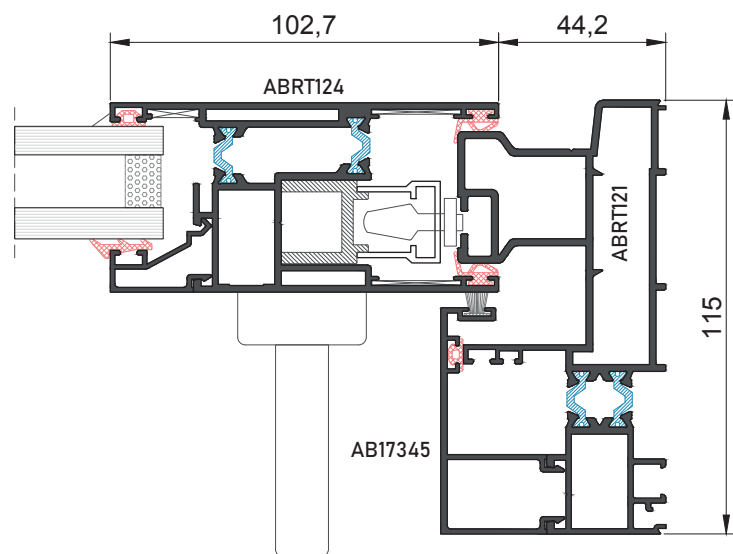

Sección 3

CORREDERA DE UNA HOJA MAS FIJO

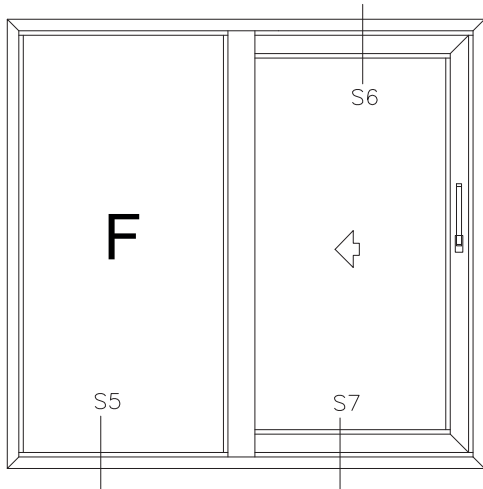

ALZADO

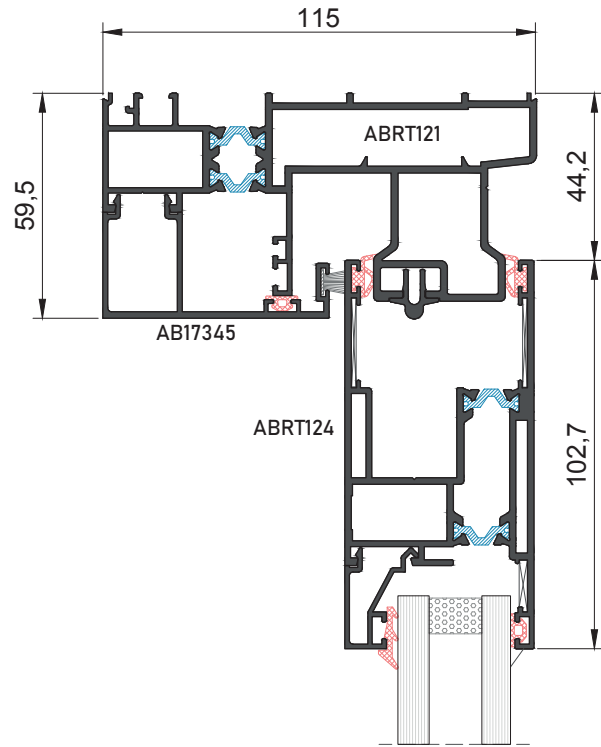

Sección 6

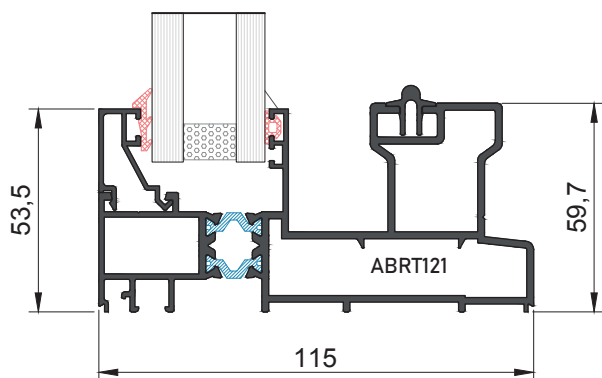

Sección 5

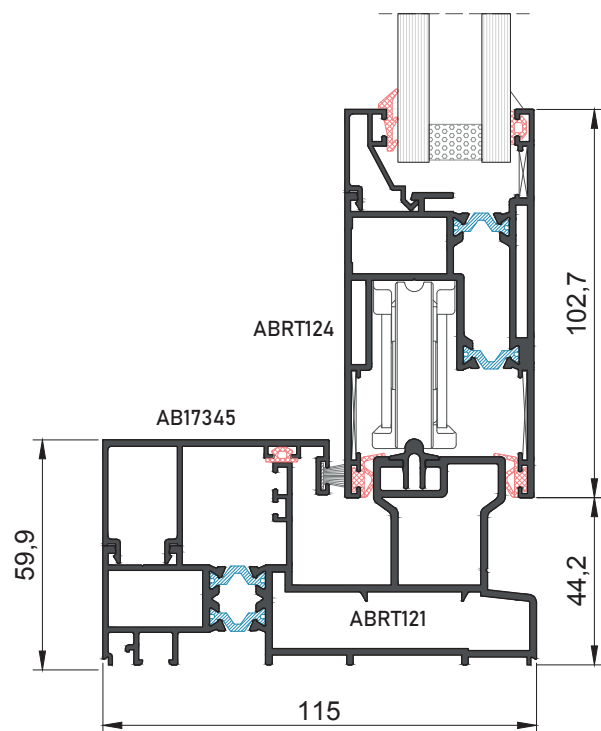

Sección 7

CORREDERA DE UNA HOJA MAS FIJO Y CON FIJO SUPERIOR

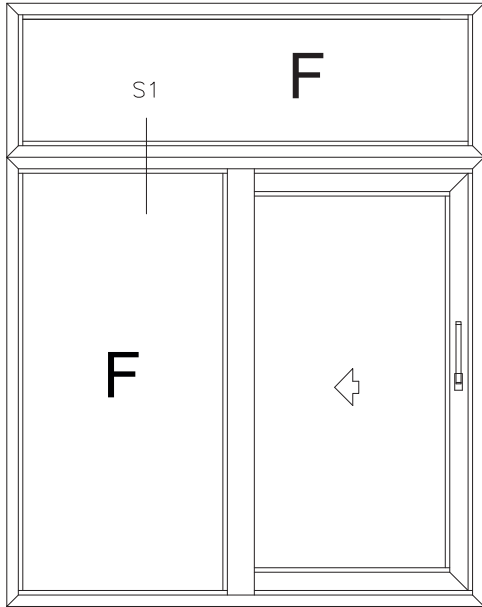

ALZADO

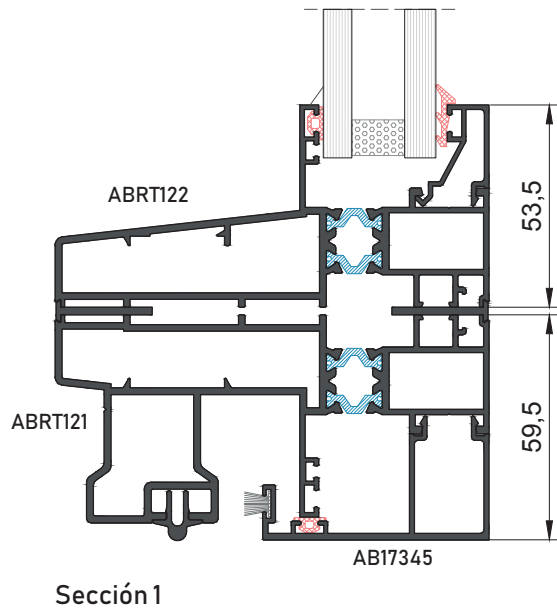

CORREDERA DE UNA HOJA MAS FIJO

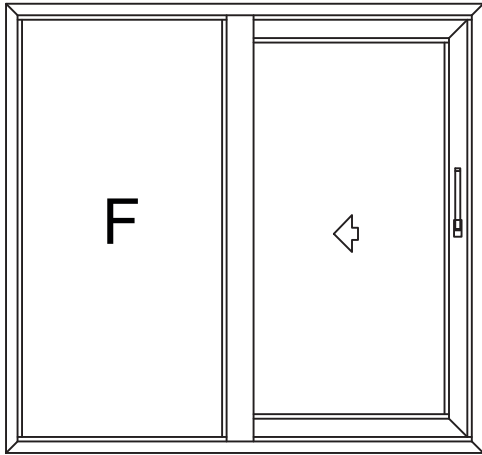

ALZADO

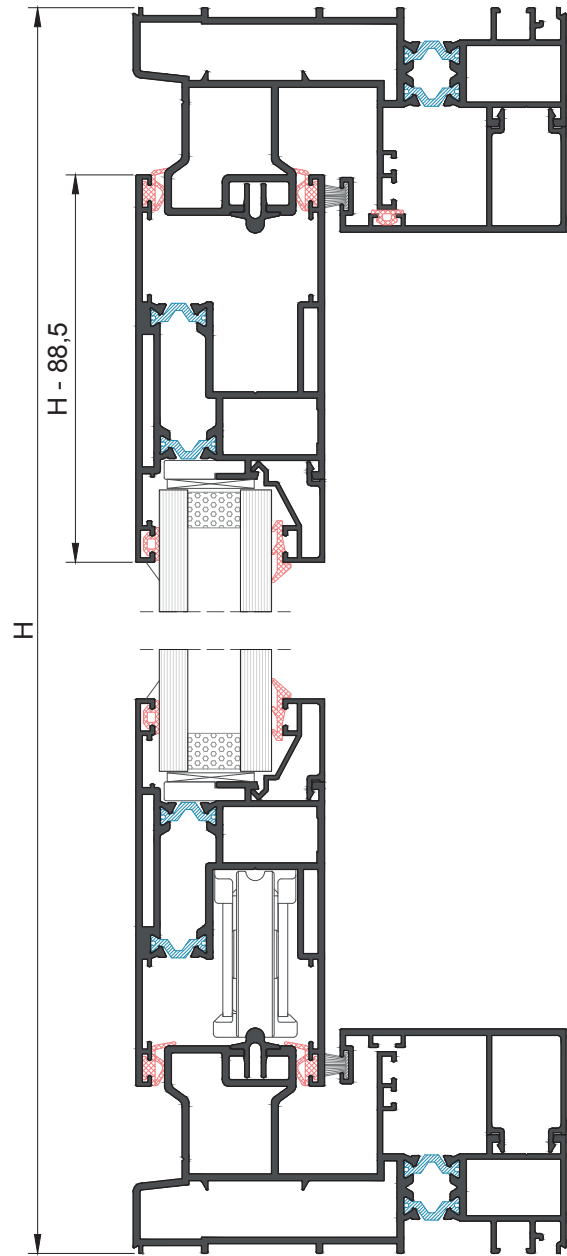

SECCIÓN VERTICAL

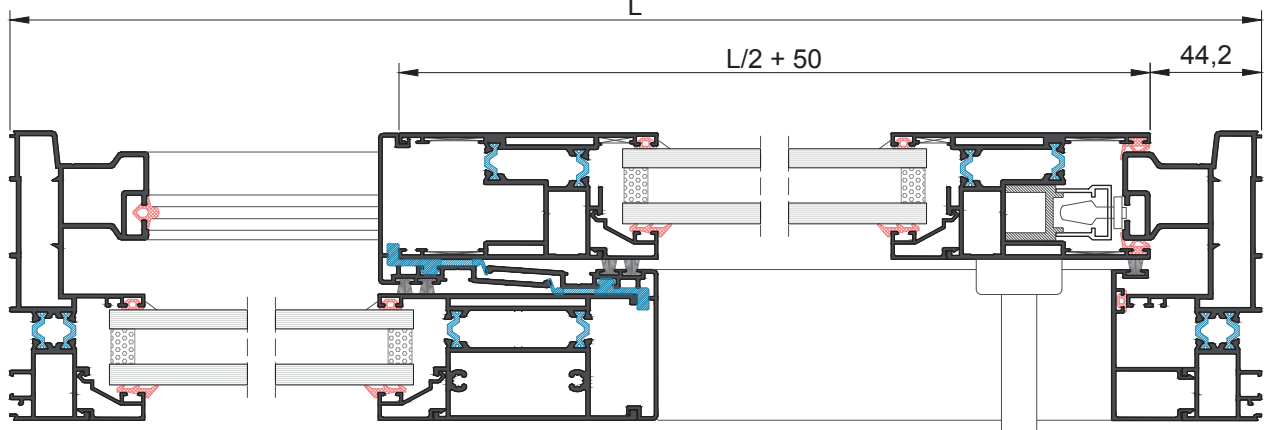

SECCIÓN HORIZONTAL

CORREDERA DE DOS HOJAS MAS DOS FIJOS

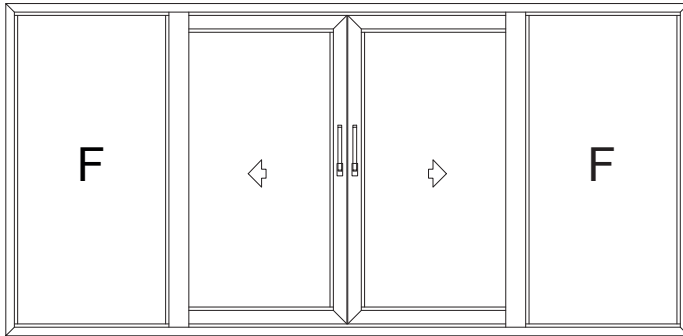

ALZADO

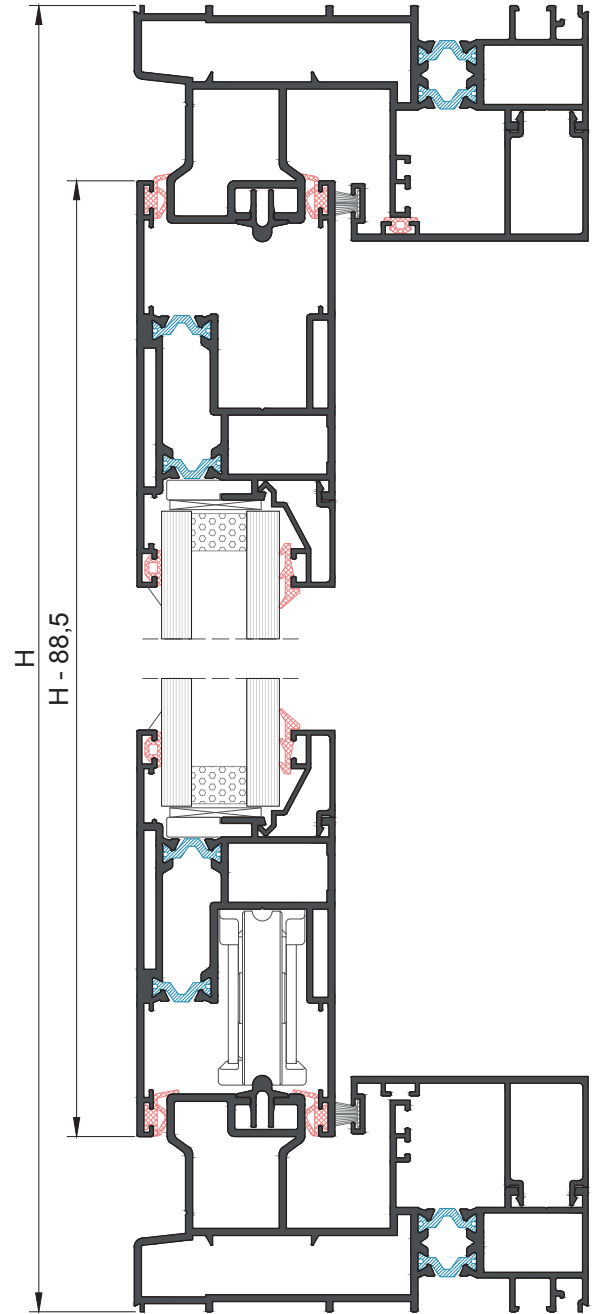

SECCIÓN VERTICAL

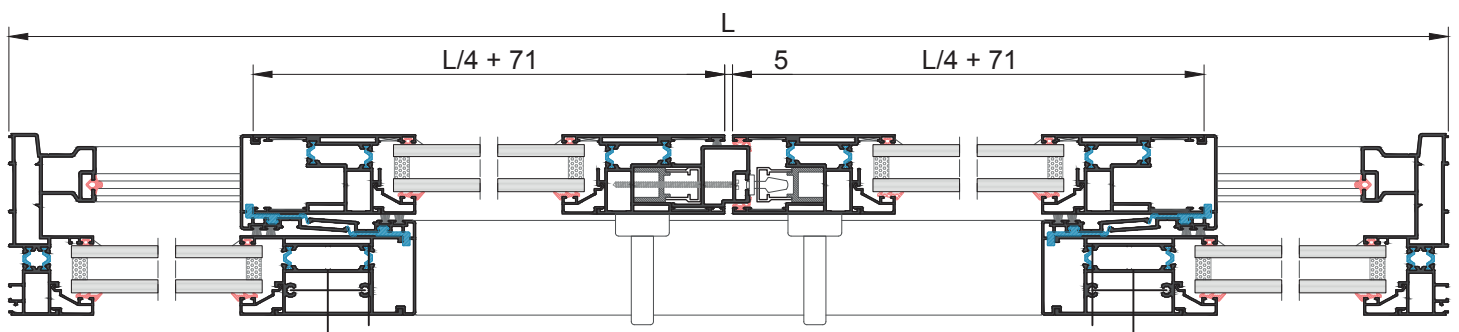

SECCIÓN HORIZONTAL

CORREDERA DE DOS HOJAS CRUCE PANORÁMICO

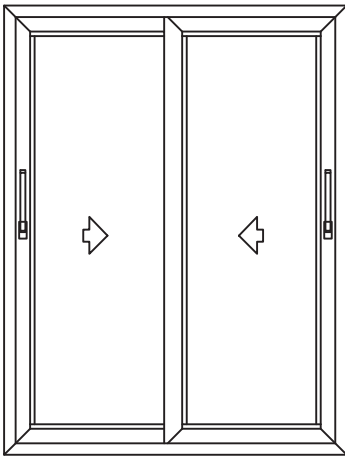

ALZADO

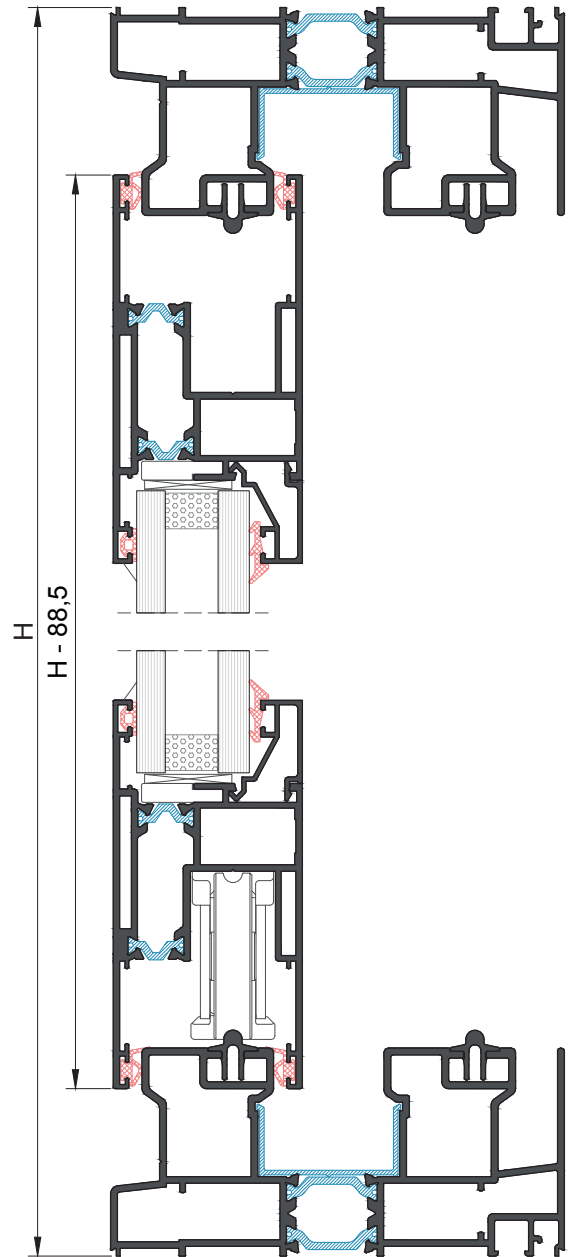

SECCIÓN VERTICAL

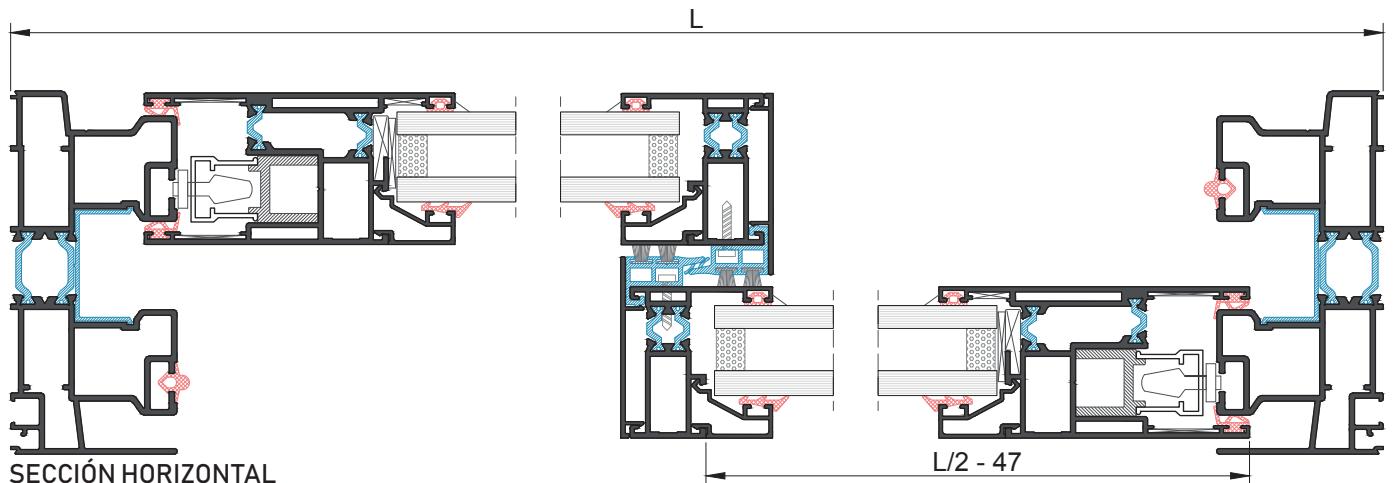

SECCIÓN HORIZONTAL